

OWNER'S MANUAL

Quality. Uncompromised.

ROTEL®

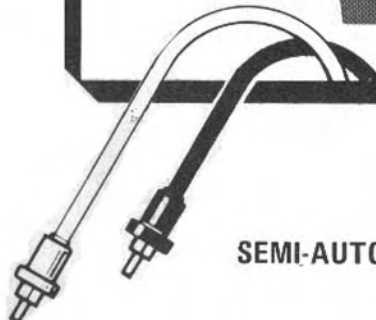
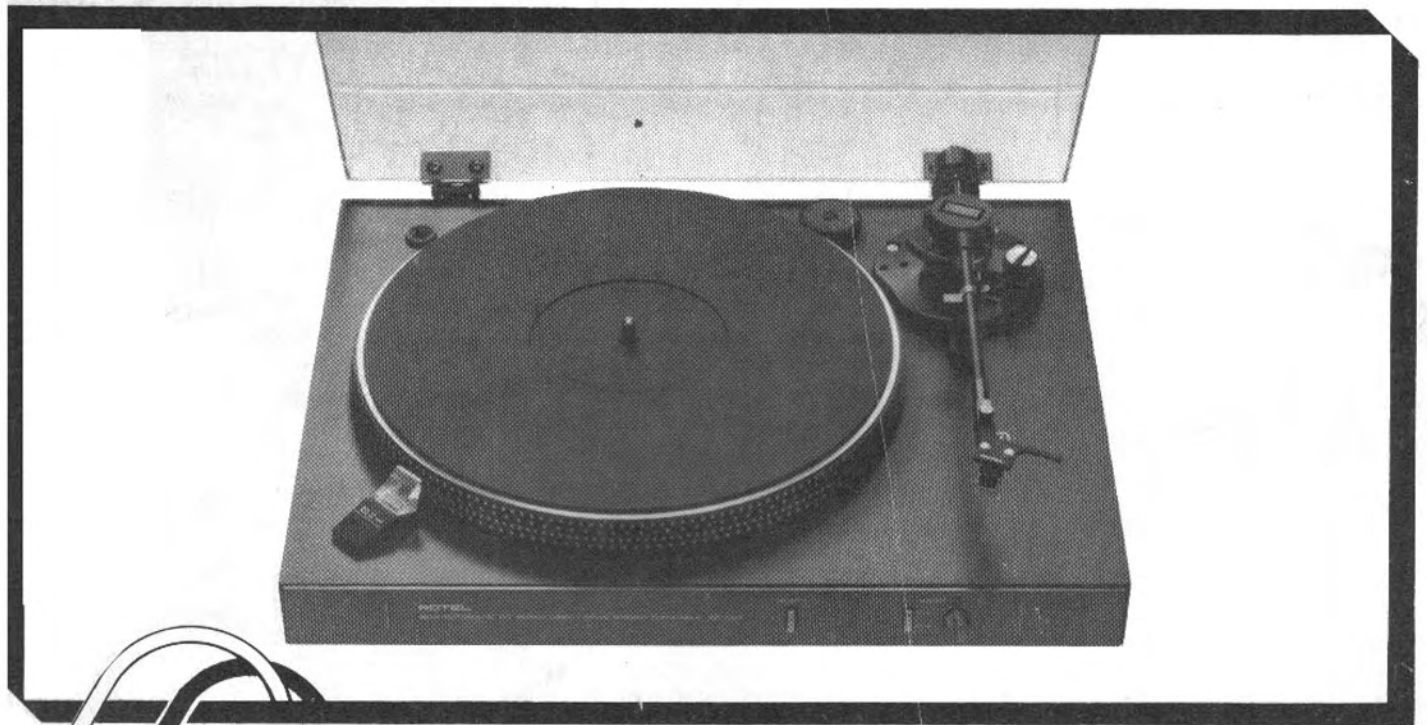

SEMI-AUTOMATIC DIRECT DRIVE
STEREO TURNTABLE

RP-1001

WARNING: TO PREVENT FIRE OR SHOCK HAZARD, DO NOT EXPOSE THIS APPLIANCE TO RAIN OR MOISTURE



Write your SERIAL NUMBER here.
The number is located near the name plate
on the unit's rear panel.

THE ROTEL CO., LTD.

1-36-8 Ohokayama, Meguro-ku, Tokyo, Japan

INTRODUCTION

We at Rotel want to thank you for purchasing our audio product.

Rotel audio products are designed to use the latest electronic technology, and they incorporate our long experience as a specialist manufacturer of audio equipment. We are confident that you will find satisfaction in the high quality sound and top performance, and that you will find pleasure in the functional beauty achieved through human-engineering concept. Before starting operation, please read this instruction manual thoroughly and acquaint yourself with the proper mode of using the unit and all its connections.

We hope you will enjoy top-notch performance for many years to come.

UNPACKING

The attachments and accessories such as head shell and counter-weight are stored inside the styrofoam moulding.

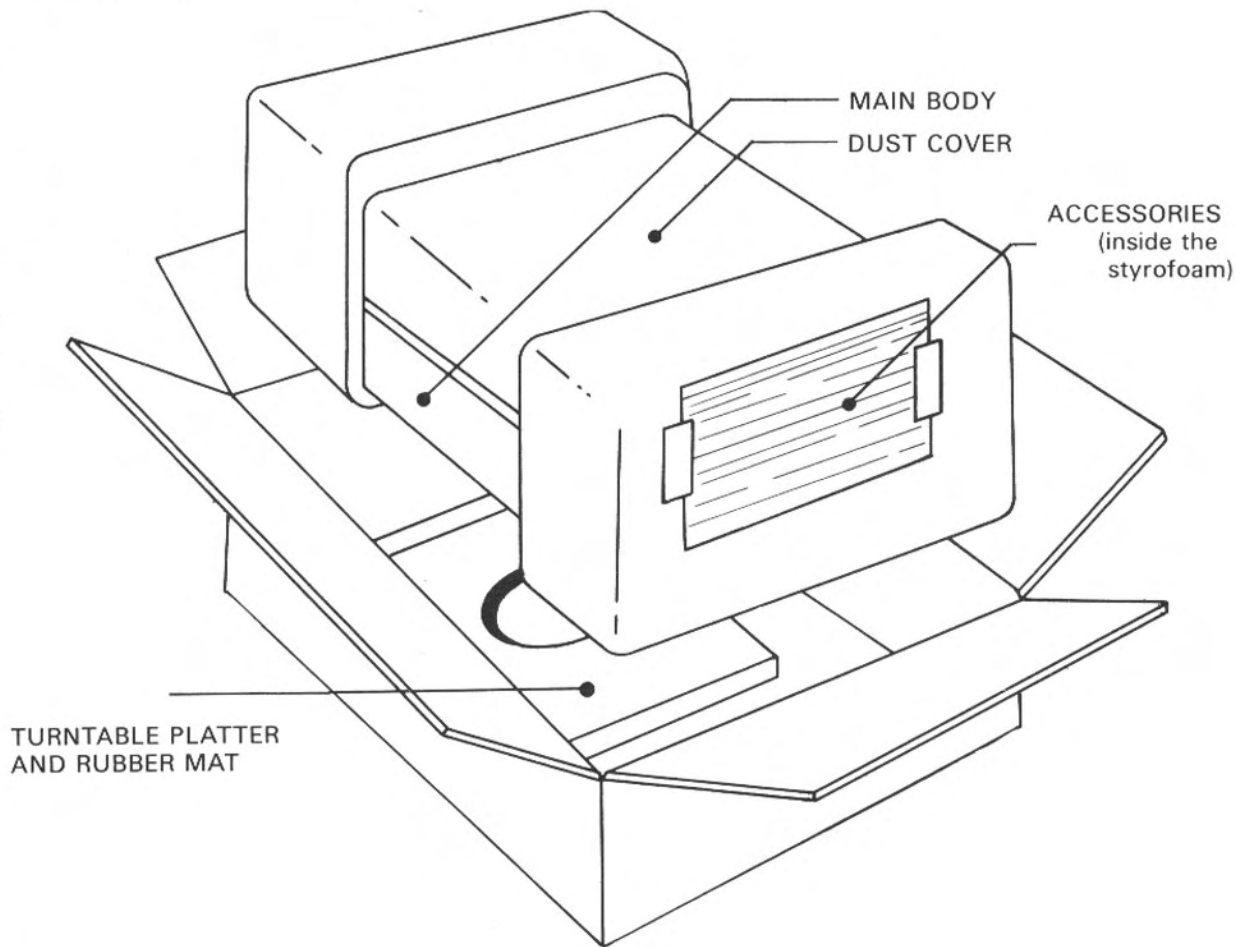

HEADSHELL

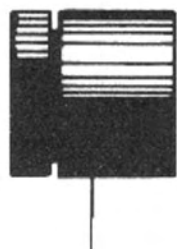

BALANCE WEIGHT

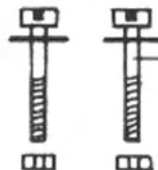

CARTRIDGE MOUNTING SCREWS



EP ADAPTER

PART NAMES

- (1) Head shell stand
- (2) Turntable shaft
- (3) Turntable/rubber mat
- (4) Strobe light
- (5) EP adapter (with overhang gauge)
- (6) Counterweight
- (7) Stylus force gauge
- (8) Anti-skating device
- (9) Cueing stick
- (10) Arm rest/clamp
- (11) Tonearm
- (12) Head shell
- (13) Stop/reject button
- (14) Speed selector

Leave the switch in the out position for 30cm records, or set it to the in position for 17cm records.

- (15) Speed control knob
- Turntable speed can be adjusted for both 33 1/3 rpm and 45 rpm: Turning the knob to the + direction will increase turntable speed and turning to the - direction will decrease the speed.

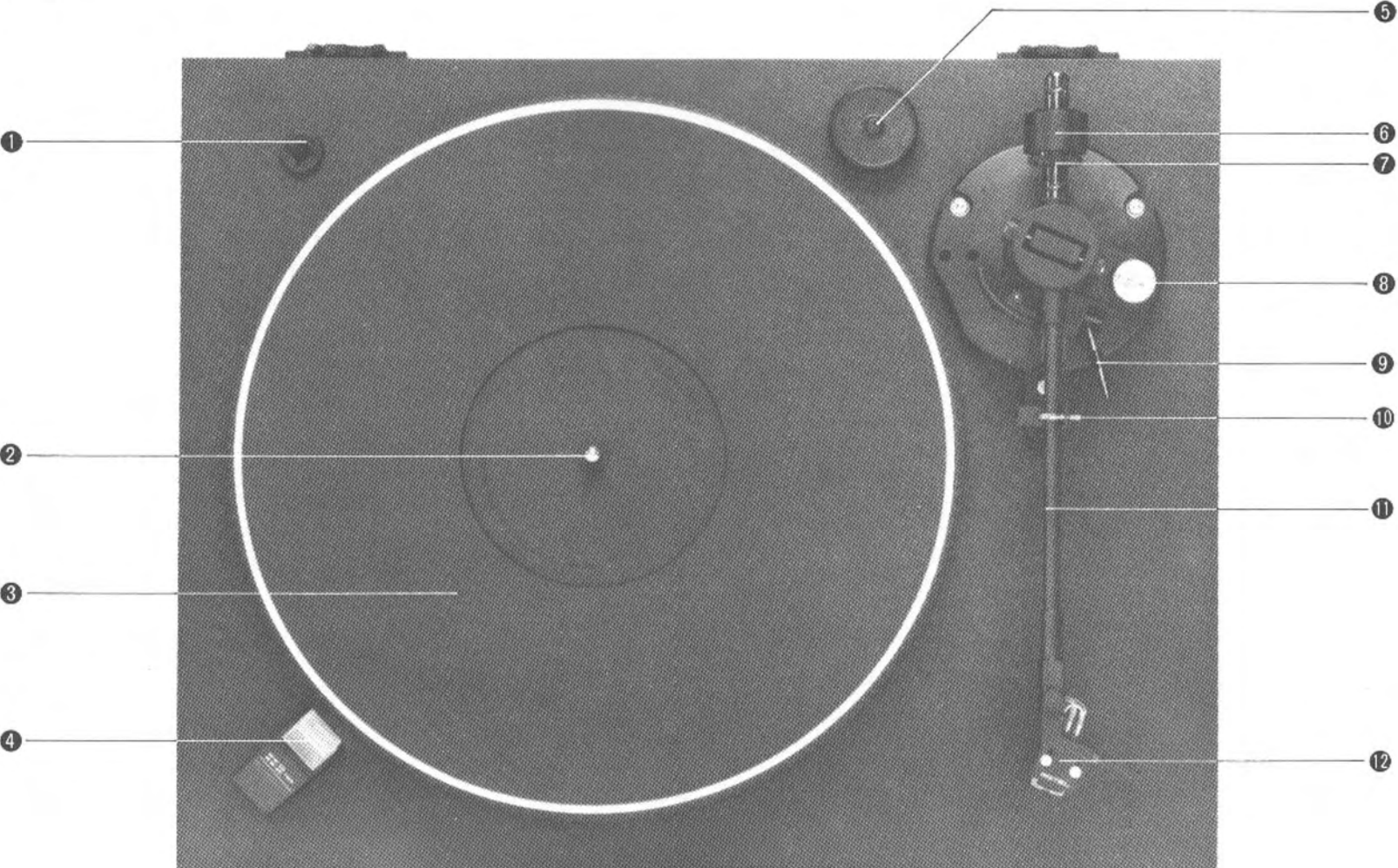

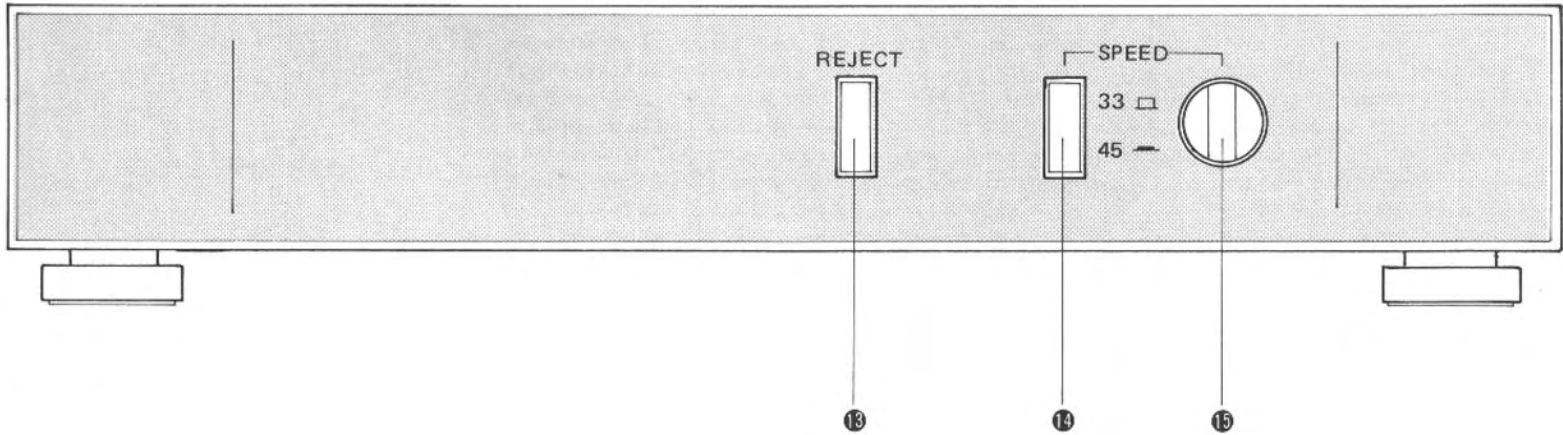

INSTALLATION

Do not place the unit near appliances that utilize motor or large transformers to prevent hum. Be sure to place the unit in a place where it is free from high temperature, humidity and not exposed to direct sunlight to prevent possible troubles.

Vibrations and unlevel installation will affect the performance of the turntable adversely and the stylus skip grooves.

POWER SUPPLY CONNECTION

For power the unit requires the normal household current (AC). You may simply plug the unit to a wall outlet, or to your amplifier's (or receiver's) convenience receptacle on the rear panel. If it is plugged to a convenience receptacle marked "SWITCHED," you cannot operate the unit when the power switch on the amplifier or receiver is set to OFF.

CONNECTION TO AMPLIFIER OR RECEIVER

The unit is provided with RCA cords for both channels, and a ground wire. The RCA cord with white wire should be connected to L (left channel) of PHONO terminals and the cord with red wire to R (right channel) of PHONO terminals on the amplifier or receiver. Connect the ground wire to GND terminals on the amplifier or receiver.

EXCLUSIVE NOTE FOR U.K.

If your unit comes with a 2-core cable without a plug, make certain live and neutral leads are connected to the proper terminals. Check that the terminals are screwed down firmly and no loose strands of wire are present.

IMPORTANT: The wires in this mains lead are coloured in accordance with the following code:

BLUE: NEUTRAL
BROWN: LIVE

As the colours of the wires in the mains lead of this apparatus may not correspond with the coloured markings identifying the terminals in your plug pro-

ceed as follows.

The wire which is coloured BLUE must be connected to the terminal which is marked with the letter N or coloured BLUE or BLACK. The wire which is coloured BROWN must be connected to the terminal which is marked with the letter L or coloured BROWN or RED.

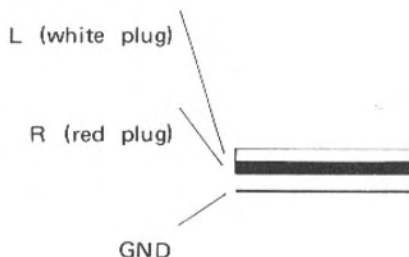

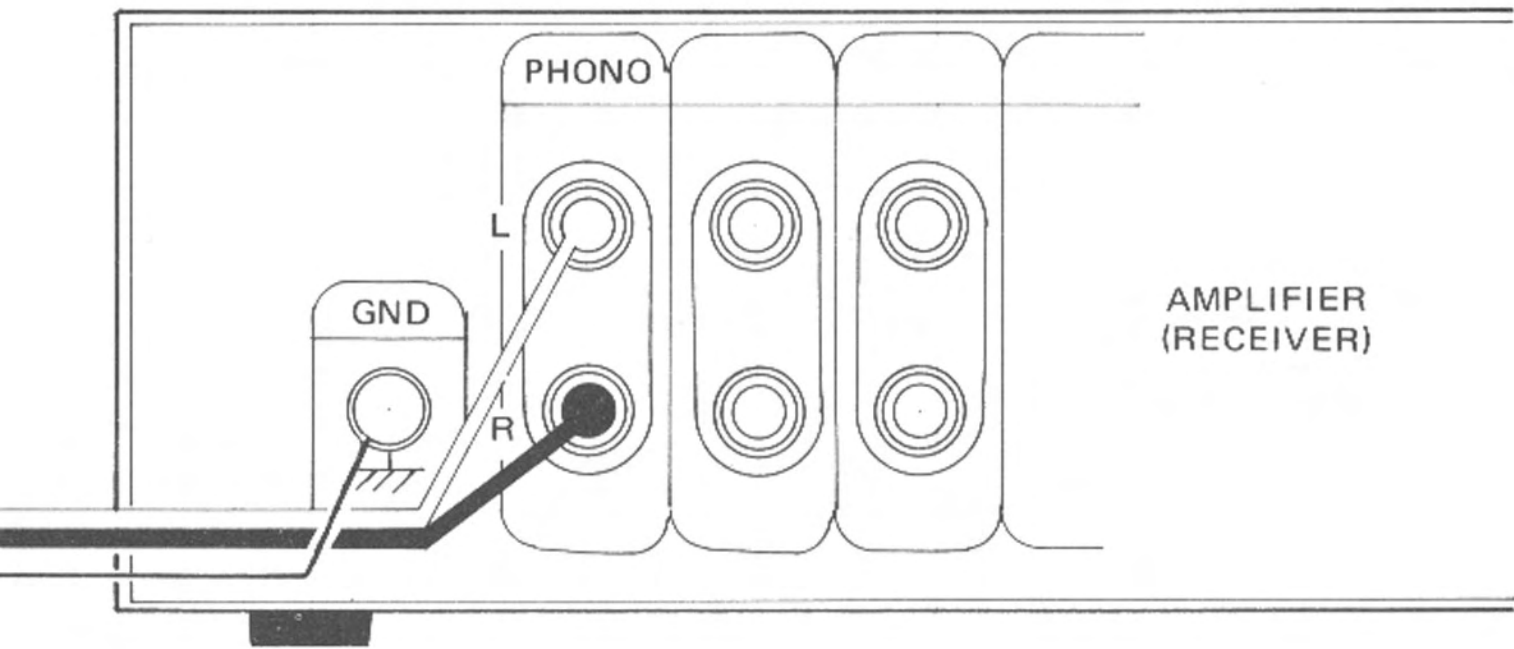

CARTRIDGE INSTALLATION

If your unit is not equipped with a cartridge, install a cartridge onto the head shell. The lead wires coming out of the head shell are specified in different colors as below. Make sure to carry out proper connection.

Green: Right/—

Blue: Left/—

Red: Right/+

White: Left/+

Fit the cartridge using nuts, bolts and washers.

ASSEMBLY

1. Set the main body on surface.
2. Put on the platter.
3. Lay the rubber mat.
4. Install the headshell.
5. Install the counterweight.
6. Fix the dust cover.

2

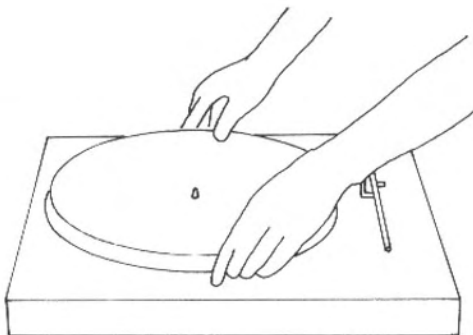

3

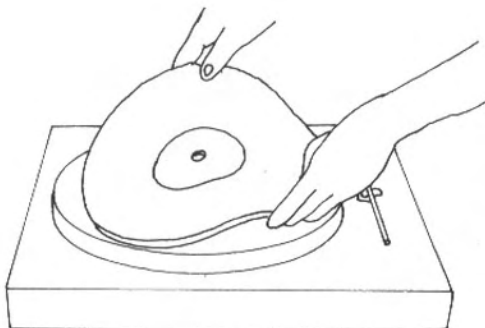

4

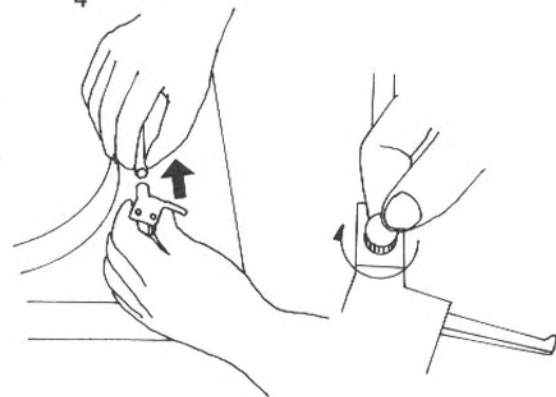

5

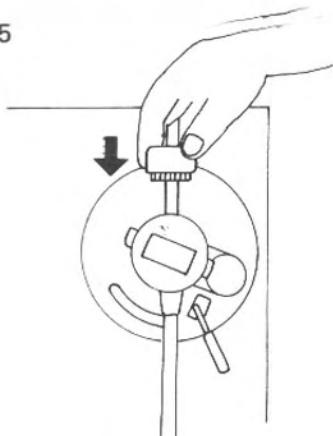

6

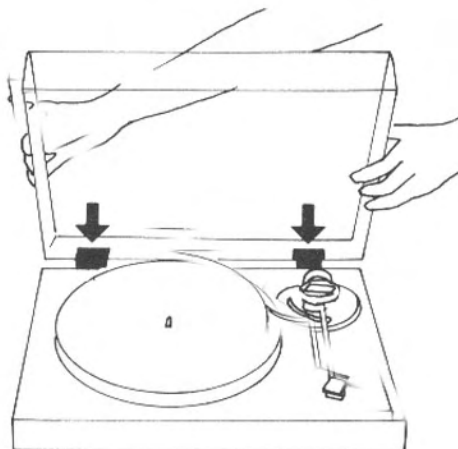

OVERHANG ADJUSTMENT

- Use an overhang gauge for correct adjustment.
- Overhang has been factory-adjusted for the unit equipped with Rotel cartridge.

As shown in the illustration, overhang indicates the distance from the stylus tip to the center of the turntable shaft when the stylus tip falls on the extension of the line drawn from the fulcrum of the tonearm to the center of the shaft. If the overhang adjustment is not properly set, the stylus will not be able to trace the record grooves correctly.

1. Loosen the two cartridge mounting screws.
2. Attach the furnished EP adaptor with overhang gauge to the turntable shaft.
3. Position the tonearm over the shaft of the turntable.
4. Slide the cartridge forward or backward until the distance between the stylus and the center of the shaft corresponds to the specified value* of your cartridge, using the gauge marked on the EP adaptor.
5. After the correct overhang is obtained, firmly tighten the two cartridge mounting screws.

Note 1: Be careful not to let fingers come into contact with the stylus.

Note 2: Overhang adjustment is not necessary for the unit equipped with Rotel cartridge.

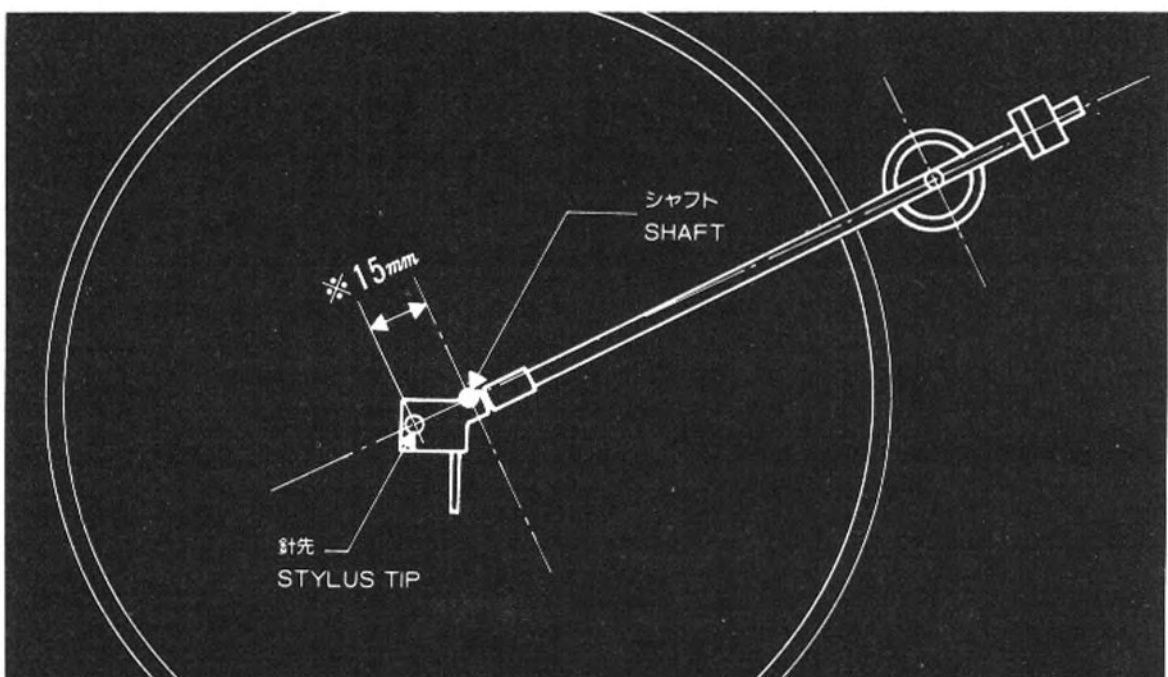

STYLUS FORCE ADJUSTMENT

Appropriate stylus force must be obtained to let the stylus trace the groove correctly. Incorrect setting of the stylus force may cause the system to skip grooves or affect the reproduced sound quality.

1. Lower the cueing stick.
2. Move the counterweight forward and backward so that the tonearm will be balanced horizontally. When balanced, the head shell is raised and the tonearm parallels the main body with the tonearm base as fulcrum. (Caution: Be careful not to drop the stylus or hit it against the platter or other objects.)

3. Return the tonearm onto the arm rest. Turn the gauge ring of the counterweight so that 0 point falls on the reference marker on the tonearm.

4. Turn the counterweight to pre-set the reading on the gauge to the designated stylus force of your cartridge. Do not touch the gauge ring, as it will turn with the counterweight.

Rotel cartridge 2RC-5 2g

5. Turn and set the anti-skating knob to the value same as the stylus force of your cartridge. Stylus force adjustment is now complete.

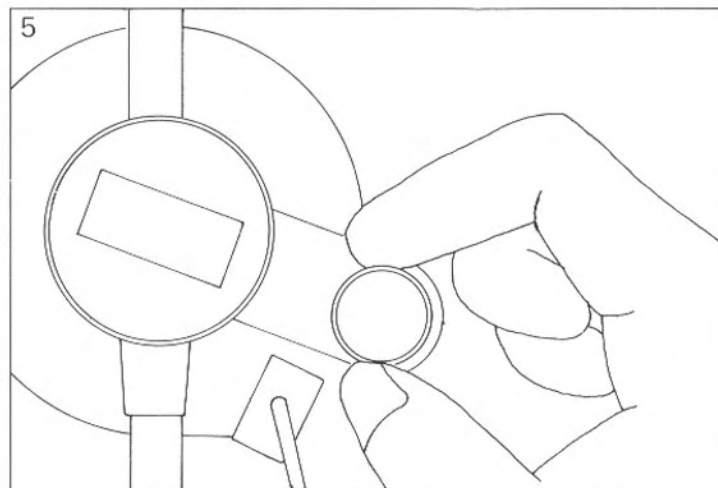
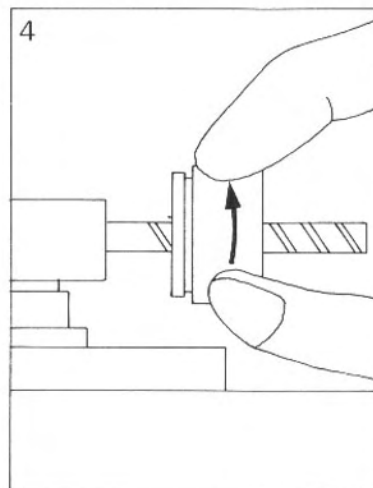
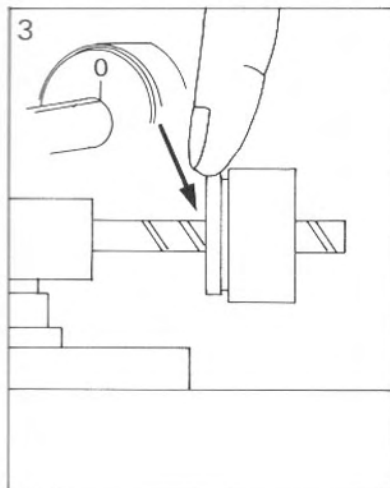
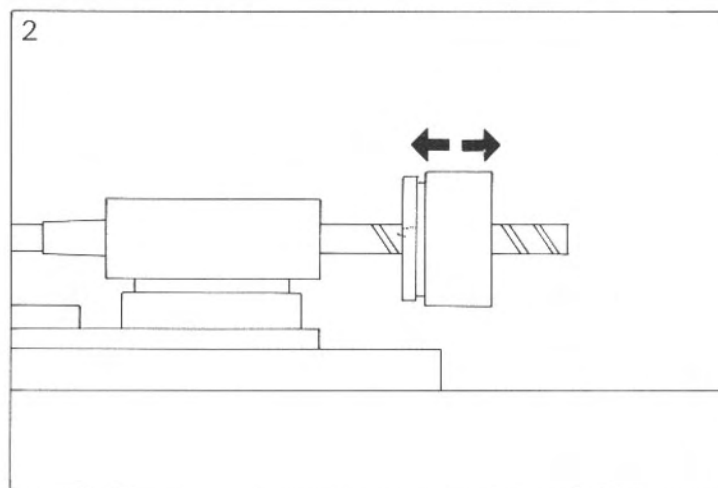
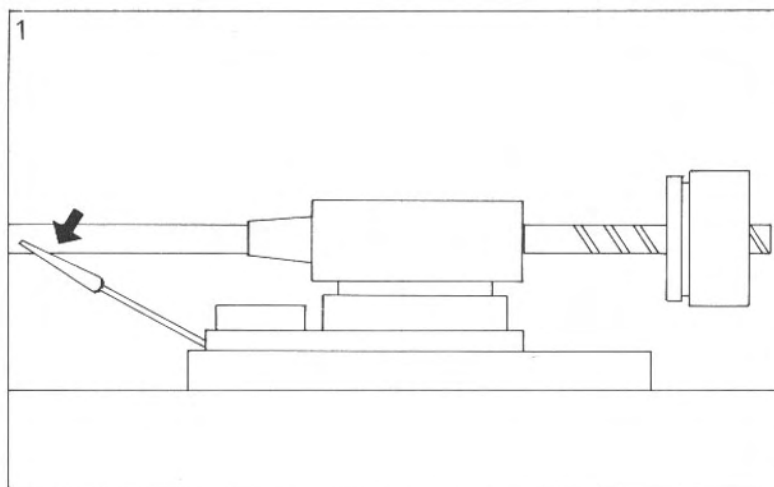

ADJUSTING TURNTABLE SPEED

The turntable speed can be fine-adjusted. During play the strobe light projects light onto the stroboscopic bars on the platter rim. Turning the speed control knob will drift the stroboscopic bars: turning the control knob to "+" direction will move the bars in the same direction of the turntable rotation, and turning to "-" direction will move in the direction opposite to that of the turntable rotation. Proper turntable speed is obtained when the stroboscopic bars remain stationary. The four rows of stroboscopic bars correspond to respective turntable speed vs. frequency of household AC as shown in the figure.

33 1/3 rpm/50 Hz
45 rpm/50 Hz
33 1/3 rpm/60 Hz
45 rpm/60 Hz

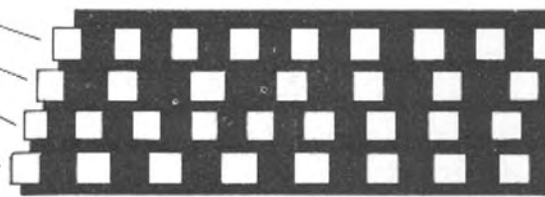

PLAY

1. Place a record on the platter. Use the EP adaptor when playing records with a large center hole.
2. Set the speed selector to the rpm of the record to be played.
3. Release the arm rest clamp.
4. Lift the cueing stick and swing the tonearm carefully to a position directly over the starting grooves of the record. This will turn the power on.
5. Check to see that the stylus is over the record. Lower the cueing stick to start transcription. If you wish to stop the turntable midway through a record, press the STOP/REJECT button. The tonearm will return to the arm rest automatically and the power will be turned off.
6. When the transcription is finished, the tonearm will return to the arm rest automatically and the power will be turned off.

MAINTENANCE

1. Keep the stylus tip clean of dust. Clean the stylus carefully using a soft brush, and ALSO clean the record before commencing play.
2. The stylus tip is very sensitive. Be careful not to touch it with a finger or do not let it come in contact with solid matters.
3. The stylus is usually good for about 500 to 1,000 hours of continuous playing. A worn stylus will cause the record to be distorted and the record to be damaged. Be sure to use the correct replacement stylus matching to your cartridge.
4. Do not move the turntable when it is operating. Never try to stop the platter forcibly by hand while it is rotating.
5. When replacing cartridge or stylus, make sure the power cord is unplugged.
6. Lubrication is unnecessary. Consult your dealer in necessity arises.
7. Keep the unit always clean. Use a soft dry cloth to clean the cabinet and the dust cover.

HOWLING AND HUM

Howling is usually caused by vibration of speakers which affects the sensitive cartridge. If such phenomenon occurs, relocate the turntable or speakers away from each other as much as possible. Hum is usually caused by the nearby appliances utilizing transformers or thermostat. Relocating the unit away from the noise sources will readily solve the problem.

SPECIFICATIONS

MotorDC coreless servo motor
DriveDirect-Drive system
Speeds33 1/3 and 45 rpm
Speed Control Range±3% (individual control for 33 1/3 and 45 rpm)
Wow and Flutter0.03%
Signal-to-Noise Ratio60dB (IEC-B) 70dB (DIN-B)
PlatterAluminum diecast (310mm diameter with strobe rim)
TypeStatic-balanced straight pipe arm, with plug-in headshell, oil-damped cueing device, direct-readout stylus gauge counterweight, anti-skating device
Overhang15mm
Tracking Error+2.5° to -1.5°
Suitable Cartridge Weight2.5g to 10g
Suitable Stylus Force0.75g to 3g

MISCELLANEOUS

Power Requirement100/120V (50-60Hz), 220/240V (50-60Hz)
Power Consumption5 watts
Dimensions (overall)W 436mm/17-5/32" H 138mm/5-7/16" D 370mm/14-9/16"
Weight (net)6.5kg/14.3 lbs.

CARTRIDGE (2RC-5) (OPTIONAL)

TypeVM (variable magnetic) type
Frequency Response20 to 25,000Hz
Channel Separation28dB at 1kHz
Load Impedance47 kohms
Compliance6.3 x 10 ⁻⁶ cm/dyne
Stylus Force Range1.5 to 2.5g
Suitable Stylus Force2.0g
Stylus Tip0.6 mil diamond
Cartridge Weight5.5g
Replacement Stylus TypeRN-5

Note: Specifications subject to change for improvement without prior notice.